

SIGMA
GERMANY

VIDEO TUTORIAL:



INSTALLATION VIDEO:



BC 5.12 / BC 8.12 / BC 8.12 ATS

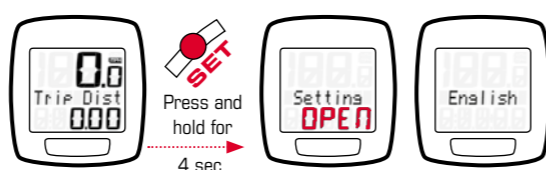

Press and hold for 4 sec.

BC 5.12 / BC 8.12 / BC 8.12 ATS

Set language / Sélectionner la langue / Seleccionar idioma

English → Spanish



→ Press mode button once to advance to wheel size setting, or press and hold the button for 4 seconds to exit.

US

Start-up:

Your bike computer comes in "deep sleep mode". To exit this mode, please press and hold the SET button for five seconds. On waking up, the bike computer will be in active mode.
(Bike Shop note: To program with the UFSB, first press and hold the SET button on the back of the computer to exit set mode.)

Button functions:

MODE button for:

- Switching between functions
- Re-setting trip values
- Changing the values in the settings mode



SET button for:

- Switching to/from the settings mode
- Confirming settings

Display layout:**Top field:** Speed**Middle field:** Name of Functions**Bottom field:** Current value**Wheel size determination:**

To measure the speed precisely, the wheel size must be set according to your tire size. To do this, you can:

- A** - Calculate your wheel size using the formula provided in the wheel size chart (13A).
- B** - Roll out: measure the outer circumference of your tire in millimeters. See wheel size chart (13B) for instructions.
- C** - Wheels Size Chart: See the chart (13C) for a list of some of the most common tire sizes. Take the value that corresponds to your tire size from the wheel size chart.

Description of functions:

- Scan mode (BC 5.12 only) → When set to SCAN ON, the display automatically changes every three seconds
- Hide functions during the trip → the total values (total distance/total time) are hidden while your bike is in motion. Only the information for the current ride will be displayed. This decreases the number of times you have to press a button to see the information that matters most on your ride.
- PC interface → the bike computer is downloadable. By purchasing the SIGMA DATA CENTER software and docking station, you can effortlessly download and analyze your total and current values on your PC. You can also configure your bike computer's settings on the PC.
- Service interval → the bike retailer can pre-program a distance so that the bike computer reminds you of your next service appointment ("Inspection" appears on the display).

Troubleshooting:**No Speed, or incorrect speed displayed:**

- Was the metal sleeve installed over the magnet?
- Computer fully twisted into mount? (is "SIGMA" on the mount facing forward?)
- Distance to magnet and sensor checked? Less than 5 mm (1/4")
- Two magnets mounted? (Or did you put your front wheel on backwards?)
- Magnet correctly positioned in relation to the sensor?
- Wheel circumference correctly set?

More troubleshooting tips can be found in our FAQs at www.sigmasport.com**Technical data:**

- Battery type: CR 2032, 3V
- Battery life: BC 5.12/BC 8.12, 3 years* / BC 8.12 ATS (computer & transmitter), 1 year* (*when used for one hour per day)

Warranty:

SIGMA's warranty policy covers manufacturer defects resulting from material or workmanship errors. The warranty does not cover batteries, normal wear and tear, or damage/loss caused by a crash or modification of the SIGMA product.

In the event of a warranty claim, please contact SIGMA USA. If our customer service department cannot help you over the phone, we will provide you with an "RA#" and request that you send your computer and a sales receipt showing that your computer was purchased within the last 2 years, to the address below. Please ensure that you pay sufficient postage.

SIGMA USA
RA#:
3487 Swenson Ave.
St. Charles, IL 60174

Upon receipt of the warranty claim, we will either repair or replace your SIGMA product with the equivalent model available at the time of replacement. The manufacturer retains the right to make technical modifications of SIGMA products at any time.

SIGMA SPORT USA

3487 Swenson Ave.
St. Charles, IL 60174
888-744-6277
sales@sigmasport.us

FCC statement:

This device complies with part 15 of the FCC Rules. Operation is subject to the following two conditions:
(1) This device may not cause harmful interference, and
(2) this device must accept any interference received, including interference that may cause undesired operation.

NOTE: This equipment has been tested and found to comply with the limits for a Class B digital device, pursuant to part 15 of the FCC Rules. These limits are designed to provide reasonable protection against harmful interference in a residential installation. This equipment generates, uses and can radiate radio frequency energy and, if not installed and used in accordance with the instructions, may cause harmful interference to radio communications. However, there is no guarantee that interference will not occur in a particular installation. If this equipment does cause harmful interference to radio or television reception, which can be determined by turning the equipment off and on, the user is encouraged to try to correct the interference by one or more of the following measures:

- Reorient or relocate the receiving antenna.
- Increase the separation between the equipment and receiver.
- Connect the equipment into an outlet on a circuit different from that to which the receiver is connected.
- Consult the dealer or an experienced radio/TV technician for help. Changes or modifications not expressly approved by the party responsible for compliance could void the user's authority to operate the equipment.

VIDEO TUTORIAL AND INSTALLATION VIDEO: WWW.SIGMA-TOPLINE2012.COM

Set wheel size / Réglage de la circonférence de la roue / Introducción de las dimensiones de la rueda

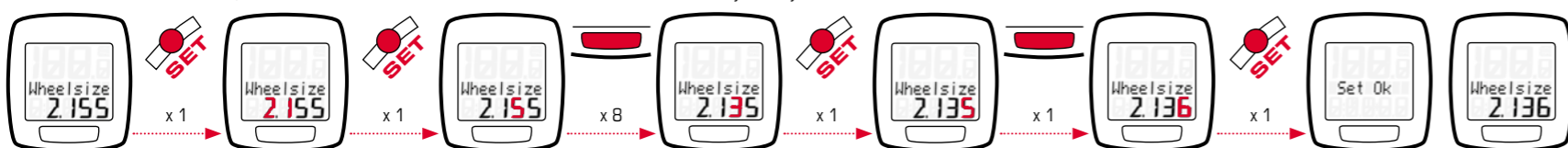
2155 → 2136 (Note: 2.155 = 2,155 mm) See wheel size chart to determine the correct number for your bicycle

→ Press mode button once to advance to Unit of measure setting, or press and hold the button for 4 seconds to exit.

Set Unit of Measure / Définir l'unité / Determinar unidad

KMH → MPH

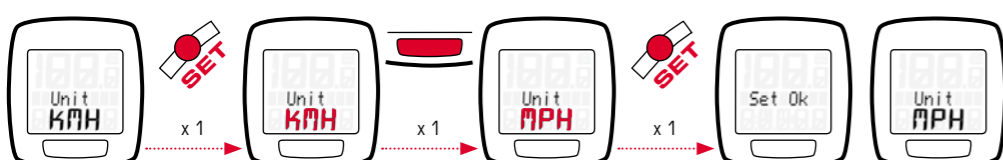

→ Press mode button once to advance to Clock setting, or press and hold the button for 4 seconds to exit.

Set clock / Régler l'heure / Ajustar hora

12:00 → 3:36pm (Note: KMH = 24h clock, MPH = 12h clock)

→ Press mode button once to advance to total distance setting, or press and hold the button for 4 seconds to exit.

Set total distance / Régler la distance totale / Ajustar tramos totales

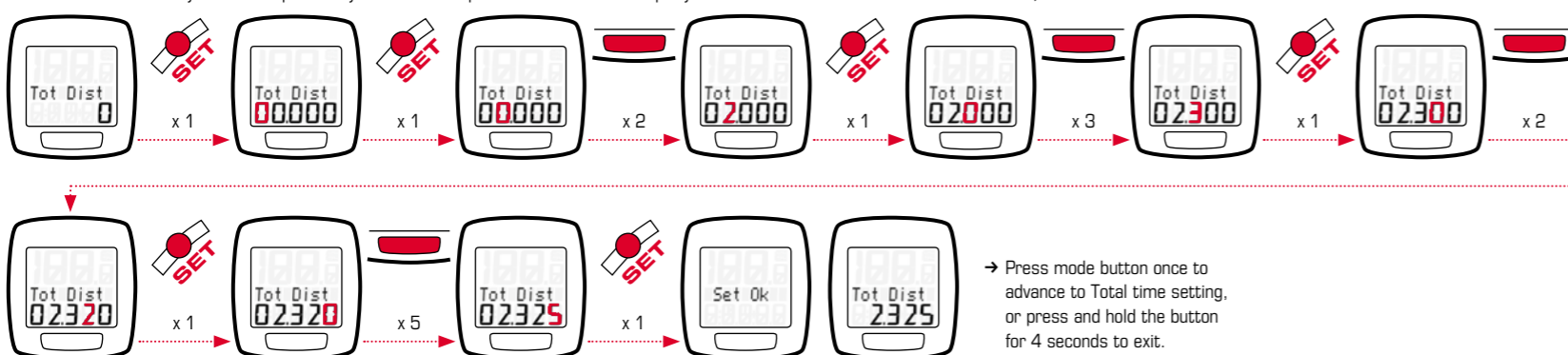
0 → 2325 (Note: allows you to enter previously ridden miles - press mode button to skip if you do not wish to add miles. Note: 2.000 = 2,000 miles)

→ Press mode button once to advance to Total time setting, or press and hold the button for 4 seconds to exit.

Set total time / Régler la durée totale / Ajustar tiempo total

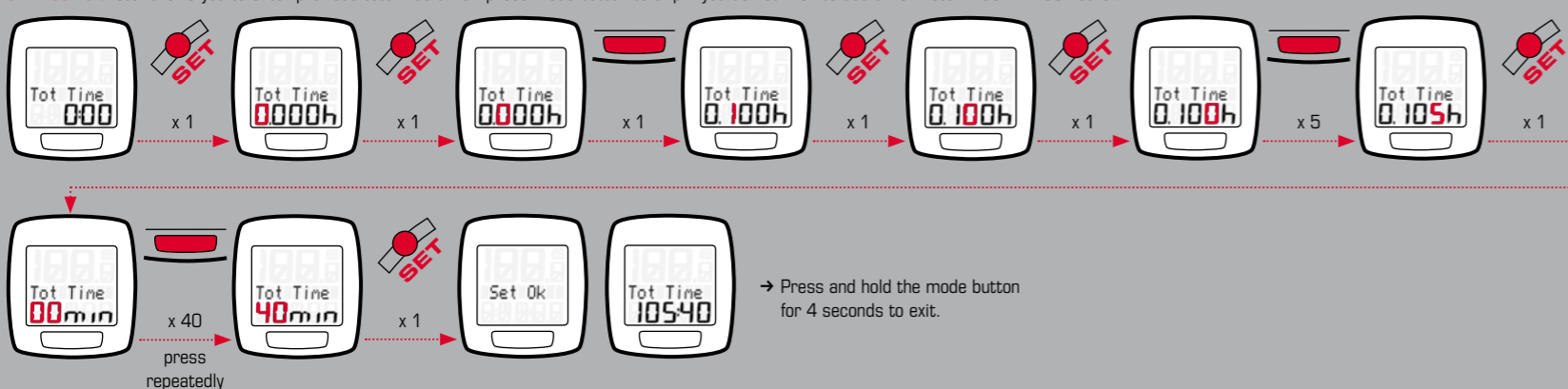
0 → 105:40 (Note: allows you to enter previous total ride time - press mode button to skip if you do not wish to add time. Note: .100h = 100 hours.)

→ Press and hold the mode button for 4 seconds to exit.

BC 8.12 / BC 8.12 ATS

Set scan mode, on/off / Activer / Désactiver le mode scan / Encender/apagar modo scan

OFF → ON

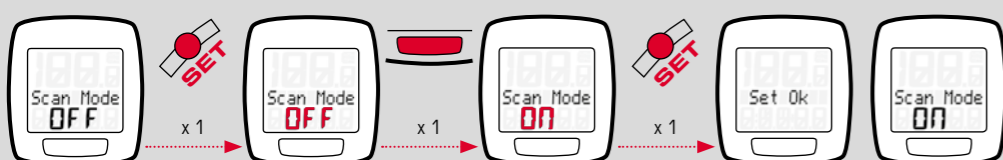

BC 5.12

Exit Setting Menu / Menu réglages / Menú de ajuste



BC 5.12 / BC 8.12 / BC 8.12 ATS

Reset current trip data / Réinitialiser / Colocar en cero

15.32 → 0.00

ES

Puesta en servicio:
En el estado de suministro, el ciclocomputador se encuentra en el modo llamado "de sueño profundo". Para poder salir de este modo, mantenga presionada la tecla SET durante 5 segundos. Una vez que se lo ha estimulado, el ciclo computador estará en el modo activo.

Ocupación de las teclas:

Tecla **MODE** para
- cambiar las funciones
- borrar los valores actuales
- modificar los valores en el modo de ajuste

Tecla **SET** para
- moverse al/del modo de ajuste
- confirmar los modos de ajuste

Estructura del display:

Segmento superior: indicación de velocidad
Segmento central: descripción de funciones
Segmento inferior: valor actual

Determinación del tamaño de rueda:
Para lograr precisión en la medición de la velocidad se debe ajustar el tamaño de la rueda de acuerdo al tamaño de su neumático. Para ello, puede:
A - Calcular el tamaño de la rueda con ayuda de la fórmula indicada en la tabla "Wheel Size Chart".
B - Calcular el valor de acuerdo a los dibujos de la "Wheel Size Chart".
C - Tomar el valor correspondiente al tamaño de su neumático de la tabla "Wheel Size Chart".

Descripción de las funciones:
- Modo scan (solo BC 5.12) → Con SCAN ON se cambia la indicación automáticamente cada 3 segundos
- Mostrar funciones durante la marcha. → Los valores totales se muestran durante la marcha (siempre que haya datos de velocidad disponibles). De esta manera deberá hacer clic en menos funciones.
- Interfaz del ordenador. → El ciclocomputador es compatible con los ordenadores. Luego de adquirir el software SIGMA DATA CENTER y la estación de conexión, podrá registrar los valores totales y actuales sin problema y rápidamente en su ordenador. Además, podrá realizar los ajustes del ciclocomputador en el ordenador.
- Intervalo de servicio. → Para recordar la próxima inspección de su bicicleta, el vendedor puede preprogramar un tramo, de modo que el ciclocomputador le recuerde la siguiente inspección (aparecerá "Inspección" en el display).

Solución de problemas:
Ninguna indicación de velocidad o indicación incorrecta:
- ¿Se ha introducido el casquillo sobre el imán?
- ¿Está el ordenador correctamente encajado en el soporte?
- ¿Se ha controlado la distancia entre el imán y el sensor?
- ¿Hay 2 imanes montados?
- ¿El imán está bien posicionado respecto del sensor?
- ¿Las dimensiones de la rueda (WS) están correctamente ajustadas?
Podrá obtener más soluciones de problemas en nuestra sección de preguntas frecuentes en www.sigmasport.com

Datos Técnicos:
- Tipo de batería: CR 2032, 3V
- Vida útil de la batería: BC 5.12/BC 8.12, 3 años* / BC 8.12 ATS, 1 año*
(*con un uso de 1 hora por día)

Garantía:
Respondemos frente a nuestra parte contratante correspondiente por defectos conforme a las prescripciones legales vigentes. Las baterías y las piezas de desgaste no están cubiertas por la garantía. En el caso de aplicar la garantía, legal dirijese al comercio en el cual ha realizado la compra del ciclocomputador. También puede enviar el ciclocomputador con su correspondiente comprobante de compra y todos sus accesorios a la siguiente dirección. Tenga en cuenta que deberá colocar el franqueo suficiente.

SIGMA-ELEKTRO GmbH
Dr.-Julius-Leber-Strasse 15
D-67433 Neustadt an der Weinstrasse
Tel. de servicio: ++49-(0) 6321-91 20-118
Correo electrónico: service@sigmasport.com

En caso de reclamación justa de la garantía recibirá un aparato de cambio. Sólo se tiene derecho a los modelos existentes en ese momento. El fabricante se reserva el derecho de realizar modificaciones técnicas.

FR

Mise en service :
A la livraison, le compteur cycle se trouve dans un état de veille profonde. Maintenez la touche SET enfoncée pendant 5 secondes pour quitter ce mode. Après avoir quitté le mode de veille, le compteur cycle se trouve en mode "Actif".

Affectation des touches :

Touche **MODE** permettant de
- Changer de fonction
- Effacer les valeurs actuelles
- Modifier les valeurs en mode de réglages

Touche **SET** permettant de
- Accéder / Quitter le mode de réglages
- Confirmer les réglages

Structure de l'écran :

Champ supérieur : affichage de la vitesse
Champ central : description des fonctions
Champ inférieur : valeur actuelle

Détermination de la taille des roues :
Pour obtenir une mesure précise de la vitesse, la taille des roues doit être réglée en fonction de la taille de vos pneumatiques. À cette fin, vous pouvez :
A - Calculer la taille des roues au moyen de la formule du tableau "Wheel Size Chart".
B - Déterminer la valeur conformément aux schémas du "Wheel Size Chart".
C - Reprendre la valeur adéquate pour la taille de vos pneumatiques dans le tableau "Wheel Size Chart".

Description des fonctions :
- Mode "Scan" (BC 5.12 uniquement) → SCAN ON permet de faire changer l'affichage automatiquement toutes les 3 secondes.
- Masquage des fonctions pendant le parcours → Les valeurs totales sont masquées pendant le parcours (dès qu'une vitesse s'affiche). Vous devez donc parcourir moins de fonctions.
- PC Interface → Le compteur cycle est compatible PC. Après avoir acheté le logiciel SIGMA DATA CENTER et la station de connexion, vous pouvez enregistrer les valeurs totales et actuelles aisément et sans effort sur votre PC. Vous pouvez également procéder aux réglages de votre compteur cycle sur votre PC.
- Intervalle de service → Pour vous rappeler la prochaine révision de votre vélo, votre revendeur peut programmer une distance de sorte que votre compteur cycle vous rappelle la prochaine révision nécessaire ("Révision" apparaît à l'écran).

Résolution des problèmes :
Pas d'affichage de la vitesse ou affichage erroné :
- La douille glissée sur l'aimant ?
- Compteur correctement enclenché dans son support ?
- Distance entre l'aimant et le capteur correcte ?
- 2 aimants installés ?
- Aimant correctement positionné par rapport au capteur ?
- Circonférence de la roue correctement réglée ?
Vous trouverez la résolution d'autres problèmes dans nos FAQ, à l'adresse www.sigmasport.com

Caractéristiques techniques :
- Type de pile : CR 2032, 3V
- Durée de vie de la pile : BC 5.12/BC 8.12, 3 ans* / BC 8.12 ATS, 1 année*
(*pour une utilisation d'une heure par jour)

Garantie :
En cas de vice, nous garantissons nos produits conformément aux prescriptions légales. Les piles et pièces d'usure ne sont pas couvertes par la garantie. Si vous souhaitez exercer votre droit à la garantie, veuillez vous adresser au revendeur auprès duquel vous avez acheté votre compteur cycle. Vous pouvez renvoyer votre compteur cycle, accompagné de la preuve d'achat et de tous ses accessoires, à l'adresse suivante :
Veuillez à correctement affranchir votre envoi.

SIGMA-ELEKTRO GmbH
Dr.-Julius-Leber-Strasse 15
D-67433 Neustadt an der Weinstrasse
Hotline de service : ++49-(0) 6321-91 20-118
Courriel : service@sigmasport.com

Un appareil de remplacement vous sera envoyé si votre requête est justifiée. Les demandes en garantie ne peuvent concerner que les modèles actuels. Sous réserve de modifications techniques par le fabricant.

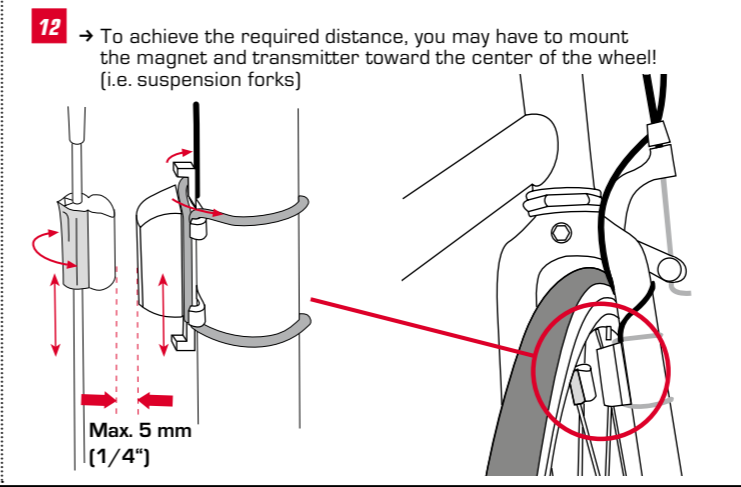
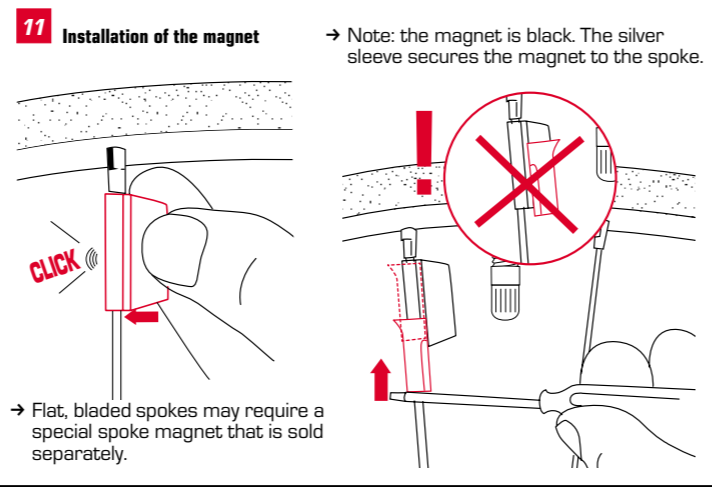
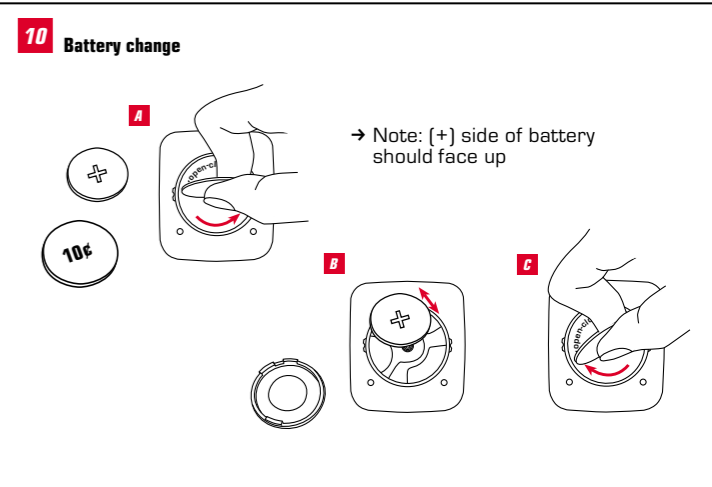
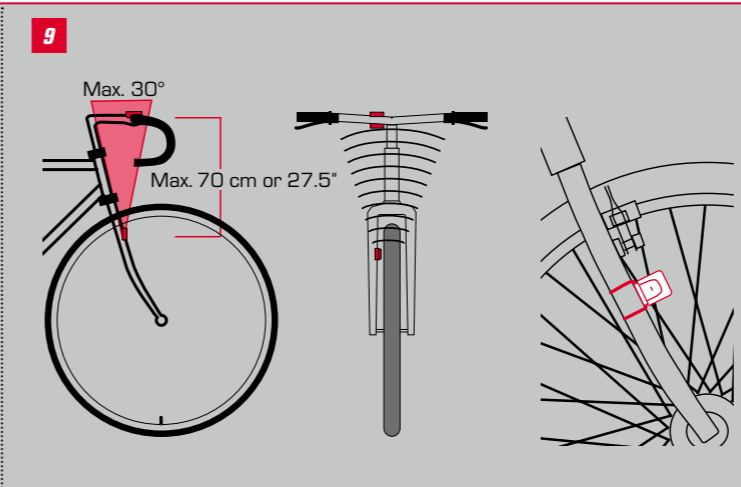
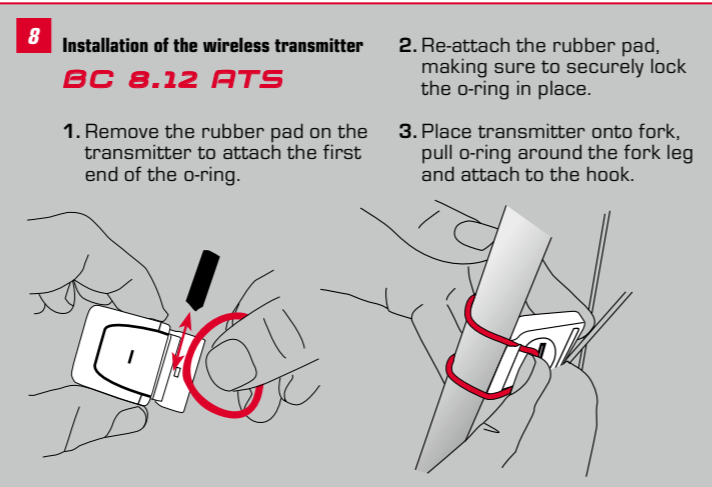
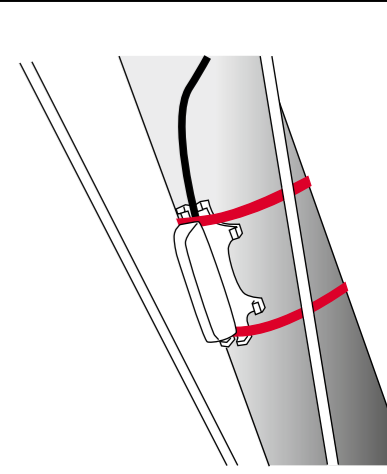
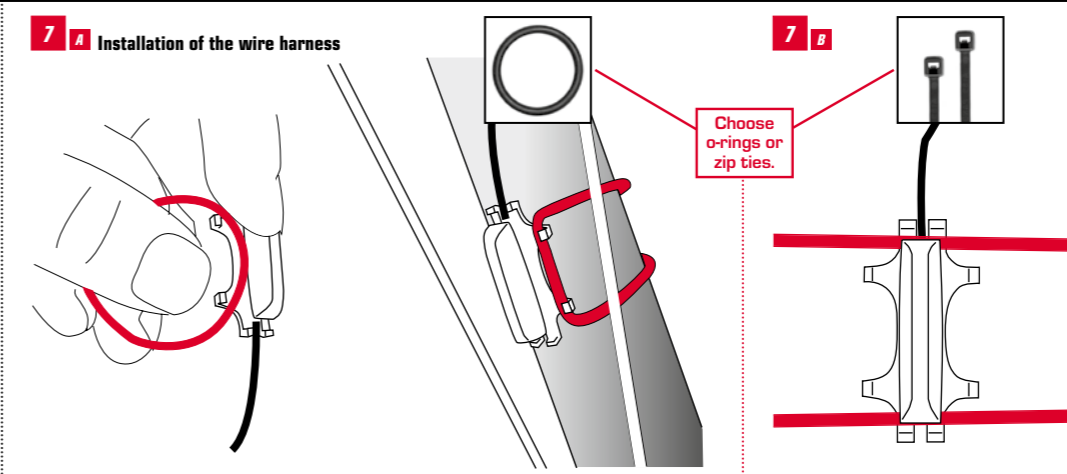
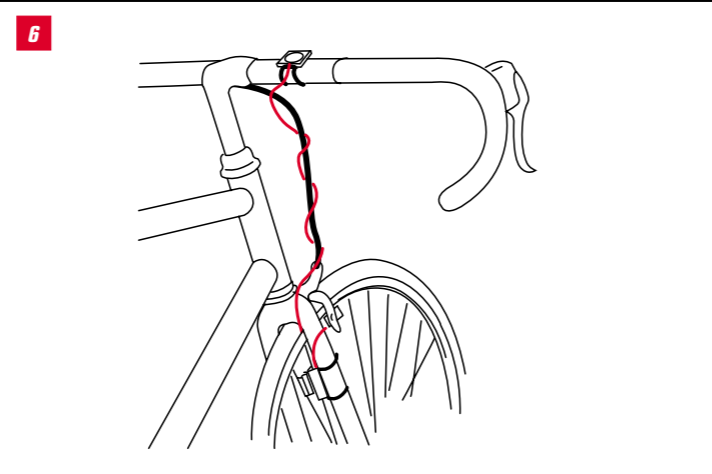
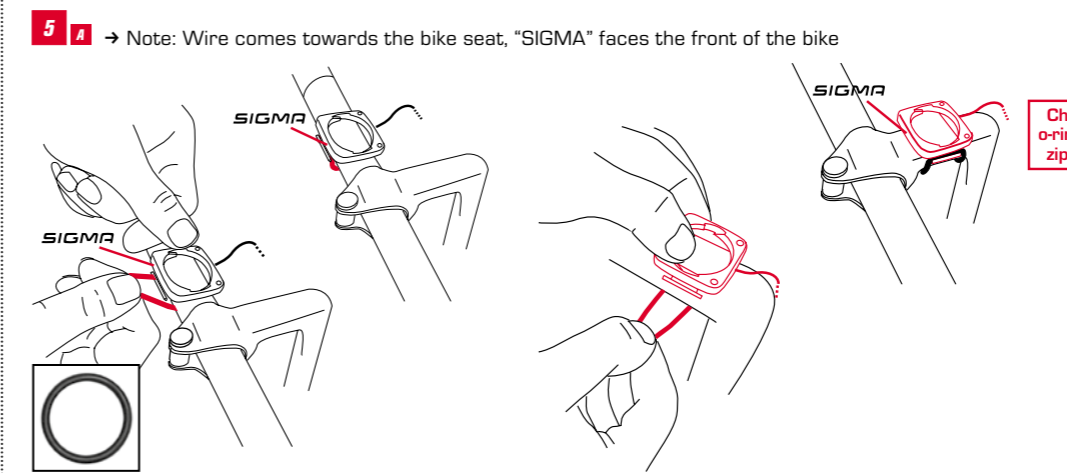
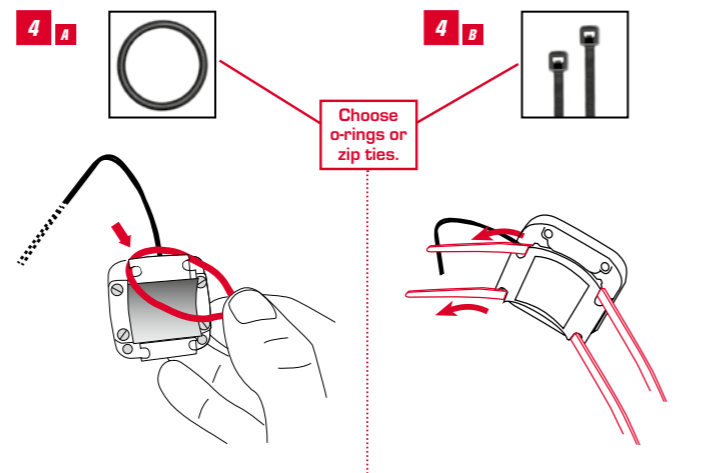
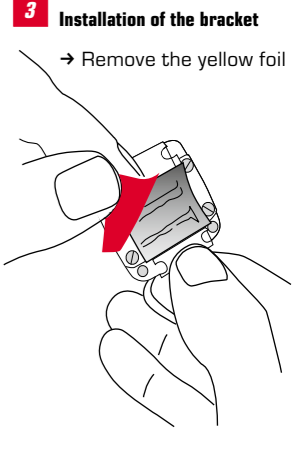
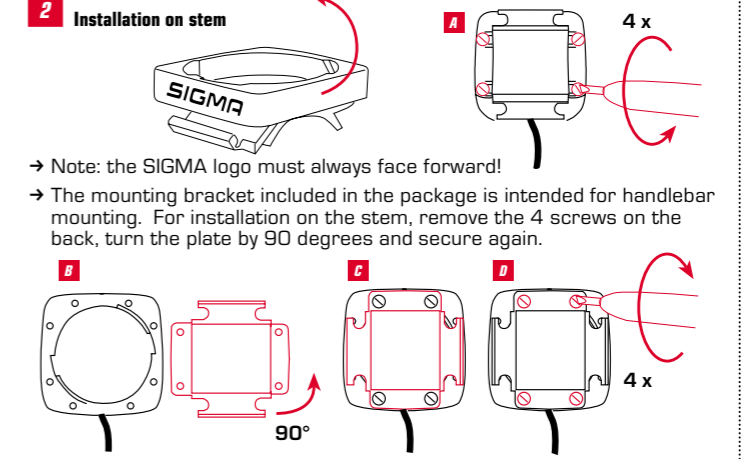
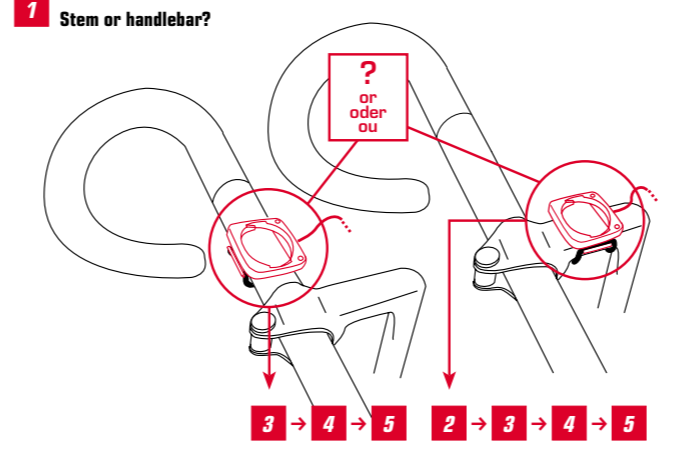
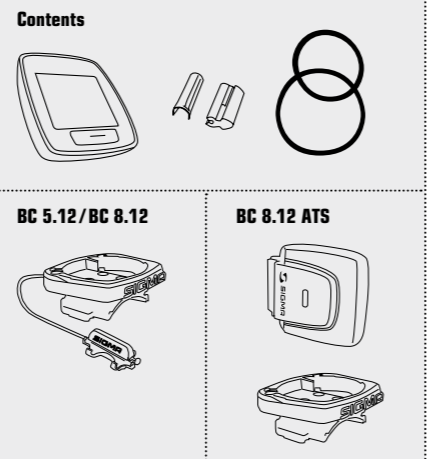

VIDEO TUTORIAL AND INSTALLATION VIDEO:
WWW.SIGMA-TOPLINE2012.COM

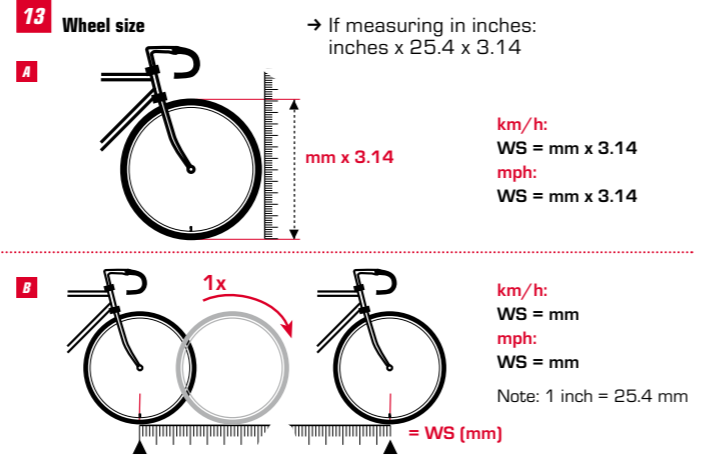

ETRTO	16 x 1.75 x 2	kmh mph	ETRTO	16 x 1.75 x 2	kmh mph
47-305	16x1.90	1272	32-622	28x1.25, 700x32C	2170
47-406	20x1.75	1580	35-622	28x1.35, 700x35C	2185
37-540	24x1 3/8	1948	37-622	28x1.40, 700x35C	2200
47-507	24x1.75	1900	37-622	28x1.40, 700x37C	2200
37-584	26x1 3/8, 650 STD	2086	40-622	28x1.50, 700x38C	2220
37-590	26x1 3/8, 650x35A	2100	42-622	28x1.60, 700x40C	2230
40-559	26x1.50	2030	47-622	28x1.75	2250
42-559	26x1.60	2025	50-622	29x2.00	2280
47-559	26x1.75	2050	54-622	29x2.10	2295
50-559	26x2.00	2075	57-622	29x2.25	2288
54-559	26x2.10	2100	60-622	29x2.35	2330
57-559	26x2.25	2120	23-571	650x23C	1973
57-584	27 1/2 x 2.25	2128	18-622	700x18C	2102
28-630	27x1 1/4	2174	20-622	700x20C	2100
32-630	27x1 1/4	2220	23-622	700x23C	2125
40-635	28x1 1/2	2265	25-622	700x25C	2135
			28-622	700x28C	2150

US Please recycle!
It is unlawful to throw batteries away in household garbage!

FR Ne pas jeter les piles aux ordures ménagères (loi relative aux piles et accumulateurs). Veuillez rapporter vos piles usagées dans un centre de collecte agréé.

ES Las baterías no deben ser eliminadas en la basura doméstica (Ley de baterías). Por favor entregue las baterías en un lugar de recogida mencionado para su posterior eliminación.

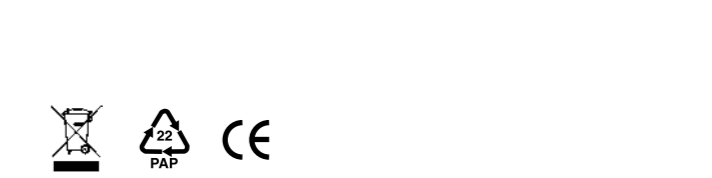

SIGMA SPORT USA
3487 Swenson Ave.
St. Charles, IL 60174, U.S.A.

Questions?
888-744-6277

085121/2